



G-700

iCreation Inc.

Unit 202, 3621 High Way 7 East, Markham ON, L3R 0G6 Canada
TM and © iCreation Inc. All rights reserved.

Product
Information Guide

Technical Specifications

Frequency Range	1.92~1.93GHz
Channels	120 Duplex channels
RF Carrier Power	<250mW
Modulation	GFSK
Frequency Stability	< 50 KHz
Charging time	15 hours
Ambient temperature	Normal: 15°C ~ 35°C, Extreme: 0°C ~ 40°C
Humidity	0%~90%
Size (mm)	Base: 179 x 106 x 43; Handset: 162 x 50 x 24
Power supply	Base input: 6V, 700/300 mA; Handset input: Ni-MH 1.2V x 2, 800mAh

**Welcome. You are using Color DECT
BT phone with Galaxy charger.**

✍ Design and specifications are subject to change without notice.

This guide contains helpful information
that enables you to enjoy all of the features
of your phone.

Introduction

Thank you for purchasing the color DECT BT phone. Your new DECT (Digital Enhanced Cordless Telecommunications) can connect to an **Galaxy** with Bluetooth function, which enables you to make calls through cell phone lines and landline. Enjoy these additional features, as well:

- Large displays and accessible menus.
- Color display - Customizable with wallpapers and backgrounds.
- **Galaxy** charger - Charge an **Galaxy** using a port on your new phone.
- Contacts list - Your personal phonebook of up to 200 listings, arranged alphabetically.
- Speakerphone - Enjoy handsfree conversations.
- 12 rings tones and sleep mode - Sleep mode automatically switches the phone to the minimum volume at night.
- Alarm clock
- Personal cordless network - Connect up to five handsets to your base. Each handset can access up to four additional base units in order to extend your total wireless coverage.

Because we are committed to continuous quality improvement, specifications and features may vary without prior notice.

Certain services, such as Caller ID, are available only if provided by your local telephone network.

Symptom	Solution
The handset works perfectly, but it doesn't ring with incoming calls.	Select another ring level.
The handset can only receive calls. The keypad locked.	Press and hold  .
The phone doesn't work properly with some special services or if it is connected to an exchange extension (PABX).	Check the Flash time and set it properly.
The battery charge level is very low.	Clean the charging pins, and if the problem is still not solved, replace the batteries.
Logical malfunctioning in the handset or base unit.	Try resetting the handset or the base.
The phone loses the connection with Galaxy .	After switching off the Bluetooth function on the Galaxy then switching on, you must connect the Galaxy again.

Chapter 10: Additional Information

Troubleshooting

Symptom	Solution
The handset doesn't turn on.	Try charging the handset for a few minutes, then remove it from the base. If it still doesn't turn on, check the battery installation.
	If these efforts are unsuccessful, try replacing the batteries.
	Contact an authorized service center.
The handset works, but it doesn't access the base unit.	Check the connection of the switching power supply.
	Try registering the handset to the base.
The handset works and it accesses the base unit, but no dial tone is heard.	Check the connection of the phone line cord.
The handset works perfectly, but a beep occurs during phone calls.	Check the batteries charge and charge them if necessary.
There is noise and audio interference during phone calls.	Get closer to the base unit. If you can access more base units, try selecting a closer one.

Warnings



Your DECT BT phone has been carefully designed to give you years of safe, reliable performance. As with all electrical equipment, however, there are a few basic precautions that you should take to avoid hurting yourself or damaging the unit:

- Read the instructions in this handbook carefully. Be sure to save it for future reference.
- Read and follow all warning and instruction labels on the equipment itself.
- Be sure to use only the switching power supply in the package, and ensure that your power source matches the rating listed for it. If you are not sure, check with your dealer or with your local power company.
- Avoid strong shocks. Don't use the switching power supply if it has received any hard knocks or looks damaged in any way; immediately contact an authorized service center.
- Hold your handset firmly. Otherwise it may fall and be damaged.
- Do not operate the phone in an explosive atmosphere.
- Do not use the phone near water, or spill liquid of any kind on it. If you think that liquid has penetrated the phone, immediately unplug it, dry it with a soft, clean cloth and contact your dealer.
- Respect the environmental conditions. All of the parts of this equipment are designed for indoor use only. Never expose them to extremely hot or cold temperatures. Don't expose the cordless telephone to excessive vibrations or dusty, rainy places.
- Never try to disassemble or service the equipment by yourself (aside from the routine maintenance described in this handbook). Doing so immediately voids the warranty, and you can cause damage requiring extensive repair work. Always contact your local dealer for assistance.
- Handle the batteries properly. Particularly, strictly follow the directions stated in this guide.
- Never use the phone with non-suitable batteries, and charge them only with the supplied base. The use of any non-genuine parts can create hazards, electric shocks and other risks, and voids the warranty.
- In case of problems, please refer to this information guide or contact your dealer or the nearest official service center. Every service operation not provided by official service centers voids the warranty.
- The phone cannot be used to place calls, including emergency calls, under these conditions: during power failure, if batteries are defective or depleted, or if the keypad is locked.
- Do not use this phone near emergency medical equipment or near people with implanted electrical devices, such as pacemakers. Additionally, radio signals between the handset and the base can interfere with hearing aids, causing strong noise.

Contents

Chapter 1: Getting Started

- 7 Features List
- 9 Phone Layout
- 10 Key Functions
- 12 Handset Screen
- 13 Package Contents
- 14 Connecting
- 14 Installing the Batteries
- 15 Charging
- 15 Turning On or Off the Phone
- 16 Registering a New Handset
- 17 Deactivating a Handset
- 18 Choosing the Dialing Mode
- 18 Setting Date & Time

Chapter 2: Bluetooth

- 20 Pairing with a **Galaxy**
- 20 Connecting a **Galaxy**
- 22 Disconnecting a **Galaxy**
- 23 Removing a Paired **Galaxy**

Chapter 3: Basic Functions

- 24 Making a Call
- 26 Receiving a Call
- 27 Using the Speakerphone
- 27 Adjusting the Volume
- 27 Muting a Call
- 28 Last Number Redial

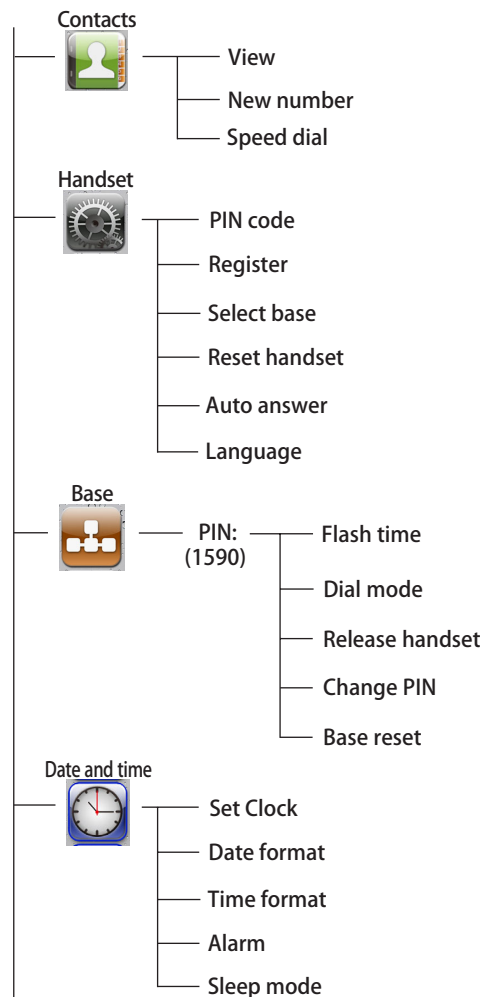

Chapter 9: Menu Structure

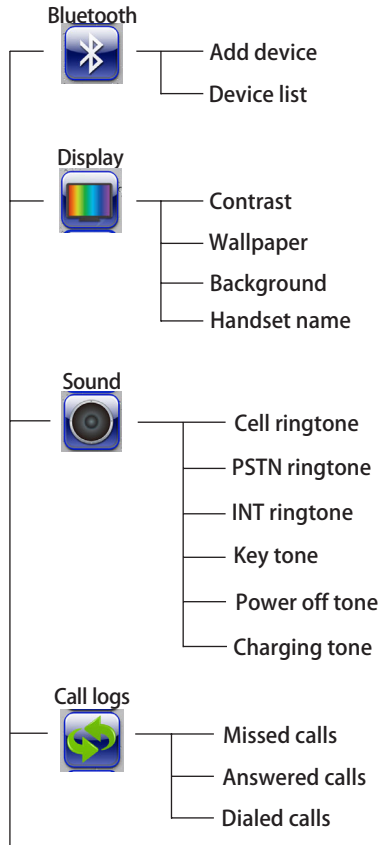

- 28 Flash Signal
- 28 Using a Pause
- 29 Out of Range Indicator
- 29 Locking the Keypad
- 30 Paging
- 30 Temporary Tone-Dial Switchover
- 31 Intercom
- 31 Transferring Calls between Handsets
- 32 Three-way Conference Calling

Chapter 4: Display and Sound

- 33 Display Contrast
- 33 Wallpaper
- 34 Background color
- 34 Handset Name
- 35 Ring Setting
- 36 Key Tone
- 36 Power Off Tone
- 37 Charging Tone

Chapter 5: Call Logs

- 38 Answered or Missed Calls
- 40 Dialed Calls List

Chapter 6: Contacts

- 41 Storing Contact Entries
- 42 Character Map
- 43 Reviewing or Dialing a Number in Contacts
- 44 Speed Dial
- 45 Editing or Deleting Contacts

Chapter 7: Settings

- 46 Changing the Handset & Base PIN
- 48 Selecting a Base
- 49 Resetting the Handset or the Base
- 51 Auto Answer
- 51 Language
- 52 Flash Time

Chapter 8: Date and Time

- 53 Date Format
- 53 Time Format
- 54 Alarm
- 55 Sleep Mode











56 Chapter 9: Menu Structure

Chapter 10: Additional Information

- 58 Troubleshooting
- 60 Technical Specifications

Sleep Mode

This feature enables you to not be disturbed by the ring tone at night. If the sleep mode is activated, the ring volume automatically switches to volume level 1 during the period of time that you set.

- 1 Press  beneath **Menu** to display the main menu items.
- 2 Press  to choose  ^{Date and time}, then press  beneath **Select**.
- 3 Press **Down**  to choose **Sleep mode**, then press  beneath **Select**.
- 4 Press **Up**  or **Down**  to choose "ON" to activate this feature or choose "OFF" to deactivate it, press  beneath **Select** to confirm.
- 5 If you choose "ON", enter the period of time that you define as sleep mode time, in 24-Hour format, and then press  beneath **OK**.















Note:

- **zZ** appears to the right of  if you activate sleep mode and set an alarm.

Alarm

You can set an alarm to ring once or ring in regular intervals about every 10 minutes.



Activating the Alarm Feature

- 1 Press  beneath **Menu** to display the main menu items.
- 2 Press  to choose , then press  beneath **Select**.
- 3 Press  beneath **Select** to choose **Alarm**.
- 4 Press **Up**  or **Down**  to choose "ON", and then press  beneath **Select**.
- 5 Use the numeric keys to enter the time using the HH:MM format.
- 6 Press  beneath **Select** to save the alarm time setting.
- 7 Press the **Left**  or **Right**  to select the ring type.
- 8 Press  beneath **Select** to save the setting and return to the previous menu.
- 9 When the alarm sounds, press  beneath **Stop** to stop it or press  beneath **Snooze** to let it ring again after 10 minutes.

Deactivating the Alarm Feature

- 1 Perform steps 1 through 3 from the last section, and then choose "OFF", and then press  beneath **Select**.

Notes:

- If you selected **12-HOUR** in the **Time format** menu, enter the time in 12h format and use the **Up**  or **Down**  to select **AM** or **PM**.
-  appears on the screen.

Chapter 1: Getting Started

Features List

Color DECT BT Phone

- 1.8G/1.9G and 2.4G DECT
- Charging cradle for GalaxyS / GalaxyS II / i9100 series
- Bluetooth connection
- Receives and makes landline and cell phone calls
- Rotated charging cradle
- Reduce cellphone radiation
- Call switch between DECT phone and your **Galaxy**
- 1.8 inches large color display
- Contacts list (up to 200 entries)
- Call log (30 missed, 30 answered, 20 dialed)
- Up to five handsets can be registered with one base
- Up to four bases can be registered with one handset
- 12 polyphonic and three monophonic ring tones
- Four ringer volume levels
- Three-way conference calling
- Call transfer
- Call hold
- Languages options
- Adjustable voice volume (5 levels)
- Adjustable contrast (11 levels)
- Handsfree speakerphone
- High definition sound
- Key tones (selectable)
- Auto answering (selectable)
- 12 selectable wallpapers
- 9 selectable background colors
- Call duration display

- Internal calling
- Password protection
- Mute function
- Real clock (12-hour or 24-hour)
- Keypad lock
- Redial, Flash, Pause
- Preparation dialing
- Sleep mode selection
- Alarm









Landline

- FSK/DTMF Caller ID
- Incoming call indicator
- Private/Out of area notification
- Message waiting notification
- Selectable dialing mode
- Selectable Flash time

Chapter 8: Date and Time











Date Format

If you have set the date, you can choose the date format.

- 1 Press  beneath **Menu** to display the main menu items.
- 2 Press  to choose , then press  beneath **Select**.
- 3 Press **Down**  to choose **Date format**, then press  beneath **Select**. Three different date formats appear, (**MM/DD**, **DD/MM** and **MM-DD**).
- 4 Press **Up**  or **Down**  to highlight the format that you prefer, then press  beneath **Select**.

Time Format









If you have set the time, you can choose the time format.

- 1 Press  beneath **Menu** to display the main menu items.
- 2 Press  to choose , then press  beneath **Select**.
- 3 Press **Up**  or **Down**  to choose **Time format**, then press  beneath **Select**. Two different time formats appear, (**12-hour** and **24-hour**).
- 4 Press **Up**  or **Down**  to highlight the format that you prefer, then press  beneath **Select**.

Flash Time

During a conversation,  allows you to access special services offered by your telephone network or to transfer a call to another extension if you are connected to a PABX (Private Automatic Branch of eXchange).

If your  key does not work properly, you need to adjust the Flash time, as follows:

- 1 Press  beneath **Menu** to display the main menu items.
- 2 Press  to choose , then press  beneath **Select**.
- 3 You are prompted to enter the current base PIN code (the default PIN is **1590**). Use the numeric keys to enter and press  beneath **OK**.
- 4 Press  beneath **Select** to access **Flash time**. The current setting appears.
- 5 Press **Left**  or **Right**  to choose the desired flash time, then press  beneath **Save**. You can choose from 100ms, 120ms, 300ms or 600ms.

Phone Layout

Handset

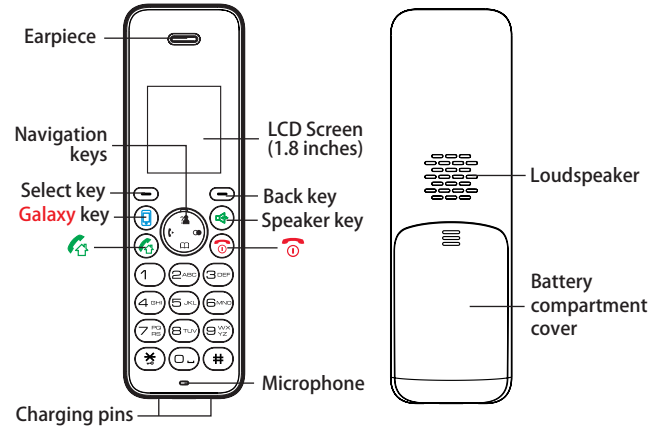

Base

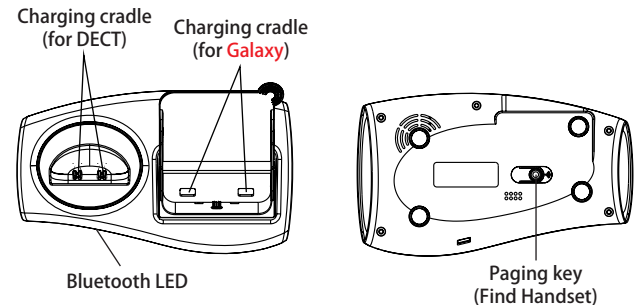

Key Functions



Press to enter # or to switch between upper case and lower case letters in the English mode.



Press and hold to turn on or off the keypad lock function.



Select keys: Press to perform the function listed above the key.



Press to turn on the phone. If you press and hold, the phone turns off. While navigating through menus, briefly press it to cancel your input and return to the main screen. During a call, briefly press it to end the call.



Press to place and answer landline calls.



Press to place and answer Galaxy calls.



Press to activate the speakerphone for handsfree operation during a call.



Press to scroll up or down when browsing menus. In standby mode:

- Left: Press to place an internal call.
- Right: Press to review outgoing calls list.
- Up: Press to view incoming calls list.
- Down: Press to review contacts.

During use:

- Up: Increases earpiece volume.
- Down: Decreases earpiece volume.

Auto Answer

You can answer a call by simply picking up the handset from the base, without pressing any key.











- 1 Press beneath **Menu** to display the main menu items.
- 2 Press to choose ^{Handset}, then press beneath **Select**.
- 3 Press **Up** or **Down** to choose **Auto answer**, then press beneath **Select**.
- 4 Press **Up** or **Down** to choose "ON" to activate this feature or choose "OFF" to deactivate it, press beneath **Select**.

Language

You can change the language used to display the menu messages. There are multiple languages available.

- 1 Press beneath **Menu** to display the main menu items.
- 2 Press to choose ^{Handset}, then press beneath **Select**.
- 3 Press **Up** or **Down** to choose **Language**, then press beneath **Select**. The current language appears.
- 4 Press **Up** or **Down** to select the language that you want, press beneath **Select**.

Resetting the Base

- 1 Press  beneath **Menu** to display the main menu items.
- 2 Press  to choose , then press  beneath **Select**.
- 3 The handset prompts you to enter the current base PIN code (the default PIN is **1590**). Use the numeric keys to enter the PIN, and then press  beneath **OK**.
- 4 Press **Up**  or **Down**  to choose **Base reset**, then press  beneath **Select**.
- 5 "B Reset ?" appears. Press  beneath **OK** to confirm.
- 6 Press .

Notes:

- Be careful! When you reset the handset, you will lose any data stored in it (e.g. Numbers in the incoming and outgoing lists). Jot them down before resetting the handset.
- Resetting the base does not affect the handsets registered to the base.

Select Keys

Press the left  or right  button to initiate the function shown above it, on the display.

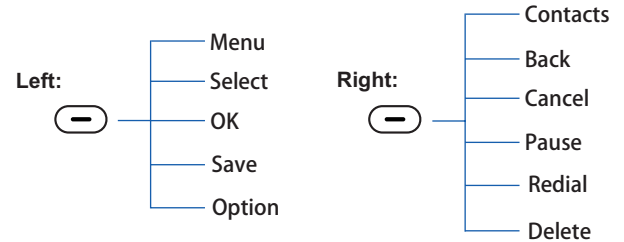



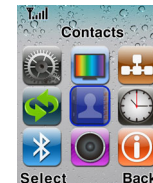









- Contacts** Enter the Contacts list.
- Back** Return to the previous menu.
- Cancel** Cancel your setting.
- Delete** Clear digits or characters.
- Pause** Insert a pause while dialing a number.
- Redial** Redial the last-dialed number.
- Select** Select the highlighted menu item.
- Save** Save a contact number.
- Option** List options during a call.
- OK** Confirm a selection.
- Menu** Enter the main menu:



Handset Screen

The screen shows various icons.

	Signal strength. The greater the number of bars, the stronger the signal.
	The landline is engaged.
	The cellphone line is engaged.
az or AZ	Indicates the case in which letters will be entered (upper case or lower case).
0-9	Indicates that only digits can be entered.
	Battery charge level.  Fully charged status  Low battery  Very low battery warning
ZZ	Sleep mode is activated.
	Alarm clock is set.
	The microphone is temporarily muted during a conversation.
	Speakerphone is enabled.
	There are one or more missed calls.
	Keypad is locked.











Resetting the Handset or the Base

If you reset the handset or the base, all of the user-selectable features restore to the factory settings: When resetting the handset, the incoming and outgoing lists will be erased, but the Contacts and Flash time do not reset.

The handset and base can be reset independently. It is useful for the following purposes:











- If you have made many wrong settings and you want to restore the handset to the factory presets.
- If the phone shows logical malfunctions (incorrect symbols on the display, incorrect behavior, etc.), the problem can be caused by a switching power supply noise or an electrostatic spike that can temporarily alter the memory of the internal microprocessor. Resetting could solve the problem.

Resetting the Handset

- 1 Press  beneath **Menu** to display the main menu items.
- 2 Press  to choose  Handset, then press  beneath **Select**.
- 3 Press **Up**  or **Down**  to choose **Reset handset**, then press  beneath **Select**.
- 4 The handset asks you to enter the current handset PIN code (the default PIN is **1590**). Use the numeric keys to enter and press  beneath **OK**. "**Reset ?**" appears. Press  beneath **OK** to confirm.
- 5 Press .

Selecting a Base

Your handset can be used with up to 4 base units, provided that it has been registered with them. This menu option enables you to select which base you want to use:

- 1 Press  beneath **Menu** to display the main menu items.
- 2 Press  to choose  ^{Handset}, then press  beneath **Select**.
- 3 Press **Up**  or **Down**  to choose **Select base**, then press  beneath **Select**.
- 4 Press **Up**  or **Down**  to select the base, then press  beneath **Select**.
- 5 Press .

Notes:

- ✓ appears to the right of the selected base.
- If the selected base has not been registered with your handset, **"Not registered"** appears.
- At step 4, if you select **"Best base"**, handset finds the first available unit as you move around.

Package Contents

Once you have unpacked your phone, make sure that you have all of these parts. If any component is missing or broken, please call your dealer.

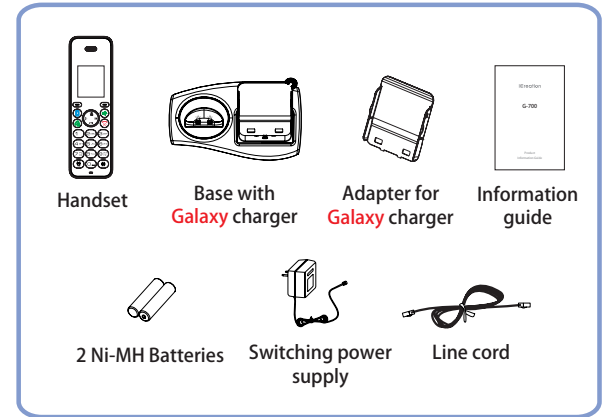

*The shapes of the plug varies according to each country's specification.

Connecting

- 1 Connect the plug of the power supply to the power jack of the base, and then plug the power supply into a standard AC wall outlet.
- 2 Connect one end of the phone line cord to the phone line jack on the base, and then connect the other end to a standard phone wall outlet.

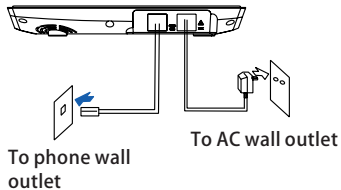







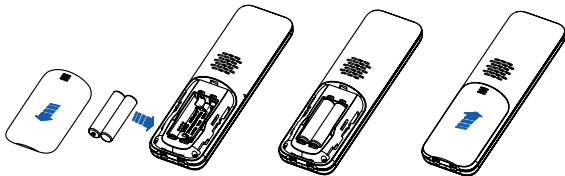

Installing the Batteries

Rechargeable Ni-MH batteries (AAA size, 1.2V, 800mAh) come with your phone. Install the batteries before use.

- 1 Slide the battery cover in the direction of the arrow, and then pull it out.
- 2 Insert new batteries as indicated, matching correct polarity (+,-).
- 3 To replace the battery cover, sliding the cover up until it snaps into place.



Base PIN









- 1 Press  beneath **Menu** to display the main menu items.
- 2 Press  to choose  , then press  beneath **Select**.
- 3 The handset prompts you to enter the current base PIN code (the default PIN is **1590**). Use the numeric keys to enter the code and press  beneath **OK**.
- 4 Press **Up**  or **Down**  to choose **Change PIN**, then press beneath **Select**.
- 5 Enter the new four-digit PIN, and press  beneath **OK**.
- 6 Enter the new PIN code again to confirm it, then press  beneath **OK** to save the setting.

Chapter 7: Settings

Changing the Handset & Base PIN

Base and handset PINs are required to protect your phone against unauthorized use. They are set to **1590** at the factory. You can change the PINs as follows:

Handset PIN

- 1 Press  beneath **Menu** to display the main menu items.
- 2 Press  to choose  Handset, then press  beneath **Select**.
- 3 Press  beneath **Select** to choose **PIN code**.
- 4 Enter the current PIN code, then press  beneath **OK**.
- 5 Enter the new four-digit PIN, and press  beneath **OK**.
- 6 Enter the new PIN code again to confirm it, then press  beneath **OK** to save the setting.

Note:

- At step 4, if you enter the wrong PIN, your phone generates a warning sound.

Notes:

- Replace batteries if they don't recover their full storage capacity after recharging.
- When replacing the batteries, always use high quality Ni-MH re-chargeable batteries. Never use other types of batteries.

Charging

DECT Phone & Galaxy

Before initial operation, fully charge the DECT phone for 15 hours or more.

To charge the DECT phone or **Galaxy**, simply place it on the base.

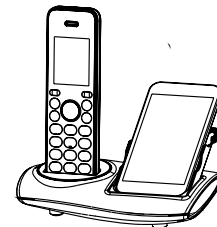

Notes:

- When charging, the bars in  scroll.
- You can adjust the visual angle of the **Galaxy** according to your needs (from 30 degrees to 75 degrees).
- Hold the base and then pull out the Galaxy after the charging.

Turning On or Off the Phone

When you place the handset (DECT phone) on the base, it automatically turns on.

To turn on the handset (when it's off), press .













To turn off the handset, press  until **"Goodbye!"** appears.

Note:

- Nothing appears on the screen when the battery power is very low. Fully charge the handset before use.





Registering a New Handset

To share your phone line with other people, you can register up to 5 handsets to your base. To do this, assign a new number to each handset that you register. The supplied handset is already registered with the number 1, appearing as 1. For security reasons, the registration procedure can only be performed by people who are close to your base and know the REGISTER PIN. Please note that this PIN cannot be modified.

- 1 On the base, press and hold  for about three seconds, and then release the button.
- 2 Press  beneath **Menu** to display the main menu items.
- 3 Press  to choose  , and then press  beneath **Select**.
- 4 Press **Down**  to choose **Register**, then press  beneath **Select**.
- 5 Press **Up**  or **Down**  to choose the base number that you want. Press  beneath **Select** to search the base. The display shows a series of characters.
- 6 Press  beneath **Select** to confirm. The display asks you to enter the AC (the authentication code is **1590**). Enter this code and press  beneath **Select**.
- 7 If the registration is successful, a confirm tone occurs and the new handset shows the handset number (e.g. 1).

Editing or Deleting Contacts













You can edit or delete a number in the contacts, as follows:

- 1 Find the desired number in the contacts.
- 2 Press  beneath **Select** to view the details of the selected entry.
- 3 Press  beneath **Select** to display the option menus.
- 4 Press **Up**  or **Down**  to choose the desired option:
 - **Edit** - allows you to edit the selected entry.
 - **Delete** - deletes the selected entry.
 - **Delete all** - deletes all of the contact entries.



Speed Dial

You can store up to 9 speed dial numbers on the numeric keypad (0~9), so you can easily dial the numbers by pressing and holding the associated numeric key.

Storing Speed Dial Numbers

- 1 Press  beneath **Menu** to display the main menu items.
- 2 Press  beneath **Select** to choose  **Contacts**.
- 3 Press **Up**  or **Down**  to choose **Speed dial**, then press  beneath **Select**.
- 4 Repeatedly press **Up**  or **Down**  to select the desired location (**KEY 1~KEY 9**), and then press  beneath **Modify**.
- 5 You can press **Up**  or **Down**  to scroll to the desired entries, and then press  beneath **Select**.
- 6 Press  beneath **Select** again to confirm.

Dialing a Speed Dial Number









Press and hold the numeric key (1~9), then press  to dial the number through your landline or dial it through your Galaxy using .

Note:

- To extend radio coverage, a handset can be registered to up to 4 different base units. A base can be used with up to 5 handsets, and one base can connect to only one handset at a time.











Deactivating a Handset

If necessary, you can clear a handset's registration, but you cannot deactivate the handset that you are using.

- 1 Press  beneath **Menu** to display the main menu items.
- 2 Press  to choose  **Base**, then press  beneath **Select**.
- 3 Enter the current base PIN (the default is **1590**) and press  beneath **OK**.
- 4 Press **Up**  or **Down**  to choose **Release handset**, then press  beneath **Select**. "**H Desub ?**" appears. Use the keypad to press the handset number for which you want to clear the registration, then press  beneath **OK**. A confirm tone occurs, and the handset cannot be used anymore with the base.

Choosing the Dialing Mode







Your phone can be set to pulse dialing (rotary), or tone dialing (DTMF). To change the dialing mode:

- 1 Press  beneath **Menu** to display the main menu items.
- 2 Press  to choose , then press  beneath **Select**.
- 3 Enter the current base PIN (the default is **1590**) and press  beneath **OK**.
- 4 Press **Down**  to choose **Dial mode**, then press  beneath **Select**. The current setting appears.
- 5 Press **Left**  or **Right**  to choose **DTMF** or **PULSE**, then press  beneath **Save** to confirm.

Setting Date & Time

Your phone can display the current date and time.







You must set the correct date and time to indicate when calls or messages are received.

- 1 Press  beneath **Menu** to display the main menu items.
- 2 Press  to choose , then press  beneath **Select**.
- 3 Press  beneath **Select** to choose **Set Clock**. The current settings are displayed:
- 4 Using the keypad, enter the current date and time (four digits for each, as explained below in the notes).
- 5 Press  beneath **Select** to save the setting.







Reviewing or Dialing a Number in Contacts

You can search stored contacts by entering the first characters of their names (alphabetic search). You can also scroll through the entire list without accessing the **Contacts** menu.

Method 1: Alphabetic Search

- 1 Press  beneath **Menu** to display the main menu items.
- 2 Press  beneath **Select** to choose .
- 3 Press  beneath **Select** to access **View**.
- 4 Enter the first few letters of the name by using the alphanumeric keys, and press  beneath **Select**. The details appear.
- 5 Press  to dial the number through your landline or dial it through your Galaxy with .

Method 2: Searching by Scrolling the Contacts List

- 1 Press **Down** . The entire list appears in alphabetical order.
- 2 Repeatedly press **Up**  or **Down**  to scroll to the desired entry.
- 3 Press  beneath **Select** to view the details of the selected entry.
- 4 Press  to dial the number through your landline or dial it through your Galaxy with .

Method 2: In Standby Mode



- 1 Enter a phone number, then press  beneath **Save**.
- 2 Complete storage by starting from Step 4 in the last paragraph of **Method 1**.

Character Map





To enter a specific alphanumeric character, press the relevant key according to the following table: once for the first character, twice for the second and so on.

Key	Characters in the displayed order	
0	(spc) 0 € £ \$ ¥ @ ÷ ☰	
1	1 . , ; ? ! - * # @ & / : () "	
2	A B C 2 Ä Ç	a b c 2 ä à ç á
3	D E F 3 É	d e f 3 è é
4	G H I 4 Ğ İ	g h i 4 ı ğ ì í
5	J K L 5	j k l 5
6	M N O 6 Ñ Ö	m n o 6 ñ ö ò ó
7	P Q R S 7 Ş	p q r s 7 ş ß
8	T U V 8 Ü	t u v 8 ü ù ú
9	W X Y Z 9 Æ Ø Å	w x y z 9 æ ø å

Notes:

- To delete letters, use  beneath **Delete**.
- If you want to shift the case while entering letter, press  .
- When entering the same letter twice or a different letter on the same key, wait for a few seconds for the cursor to move automatically, and then select the next letter.







Notes:

- If you selected **12-HOUR** in the **Time format** menu, enter the time in 12h format and use **Up**  or **Down**  to select **AM** or **PM**.
- When setting the month, you can enter 1 digit or 2 digits at a time, but it is displayed in 2-digit format. (For example: For August, you can enter 8 or 08 in the month field, but the display shows "08".)
- After the time setting, press  beneath **Select** to set the date. During the date setting, press **Left**  to switch to time setting.
- If your service uses the FSK standard, the date and time is automatically set when you receive a call to this unit.

Chapter 2: Bluetooth

Pairing with an Galaxy

To use a **Galaxy** with your DECT phone, you must first pair and connect the **Galaxy** with the DECT phone.

- 1 On the Galaxy, click  button, **Settings, Wireless and network, Bluetooth settings**, then click **Bluetooth**. When  to the left of **Bluetooth** appears as green color, the Bluetooth on the Galaxy is turned on.
- 2 On the DECT phone, press  beneath **Menu**.
- 3 Press  to choose , then press  beneath **Select**.
- 4 Press  beneath **Select** to choose **Add device**. The LCD shows **Please wait...**, and the Bluetooth LED flashes.
- 5 Click **Search for devices**, the Galaxy searches for available devices. When the Galaxy finds **G-700**, click **Pair with this device** to pair and connect it with the base, then click **Accept**. When the connection is successful, **Connected to phone audio** appears.

Connecting a Galaxy

All Bluetooth-paired devices are stored in the Device list, and only devices in the list can establish a Bluetooth connection with the DECT phone. Although seven Galaxies can be paired with the DECT phone, only one can be connected to the base and be engaged in a call at one time.

Method 1: Using the Galaxy













- 1 Click  button, **Settings, Wireless and network, Bluetooth settings**. If the Bluetooth feature is switched off, click **Bluetooth** to switch it on.

Chapter 6: Contacts







You can store frequently used numbers so that you can easily make a call without having to remember or enter the phone number. You can store up to 200 entries in your contact list.

Storing Contact Entries

Method 1: Using the Contacts Menu

















- 1 Press  beneath **Menu** to display the main menu items.
- 2 Press  beneath **Select** to choose  .
- 3 Press **Up**  or **Down**  to choose **New number**, then press  beneath **Select**.
- 4 Enter a name. For additional details, please see the "Character Map".
- 5 Press **Down**  to move the cursor to the number field, then enter the appropriate phone number (up to 16 digits). Press and hold  to insert a pause if necessary.
- 6 Press **Down**  to highlight the ring type number at the right of , then press **Left**  or **Right**  to select a ring to associate with the number.
- 7 Use the same method to associate a picture with this number, press  beneath **Save** to confirm.

Notes:

- At step 5,  or  changes to . This indicates that you can only enter digits.
- If you make a mistake while entering a number or name, press  beneath **Delete** to clear the last character. You can also use **Left**  or **Right**  to navigate to incorrect characters, then press  beneath **Delete** to clear them.

Dialed Calls List

The last 20 dialed calls are stored in the **Dialed Calls** list. You can review, redial, delete and save these numbers.









- 1 Press  beneath **Menu** to display the main menu items.
- 2 Press  to choose **Call logs**, then press  beneath **Select**.
- 3 Press **Up**  or **Down**  to choose **Dialed calls**, then press  beneath **Select**. The last dialed number appears on the screen.
- 4 Press **Up**  or **Down**  to find the desired number, press  beneath **Select**.
Press  to dial it via your landline or dial it via your Galaxy using .
- 5 Press  beneath **Select** to display the option menus.
- 6 Press **Up**  or **Down**  to choose the desired option:
 - **Add to contacts** - allows you to save the number in the contacts list. If the number is longer than 16 digits, only the first 16 digits are stored.
 - **Delete** - deletes the selected number.
 - **Delete all** - allows you to delete the entire dialed calls list (a prompt confirms your intent). Press  beneath **Select** to confirm or  beneath **Cancel** to exit without deleting the entries.

Note:





- At step 3, if the list is empty, "**No record.**" appears.

- 2 Click **Paired** below **G-700** to connect the Galaxy to the DECT phone. When the connection is successful, **Connected to phone audio** appears instead of **Paired**.

Method 2: Using the DECT Phone Menu

- 1 Press  beneath **Menu** to display the main menu items.
- 2 Press  to choose **Bluetooth**, then press  beneath **Select**.
- 3 Press **Down**  to choose **Device list**, press  beneath **Select**.
- 4 The display shows all devices that have been paired before. Press **Up**  or **Down**  to choose the desired device, press  beneath **Select**.
- 5 Press  beneath **Select** to choose **Connect**. When the connection is successful, **Connected to phone audio** appears below **G-700** on the Galaxy screen.











Method 3: Quick Connection

- 1 Press  on the DECT phone.
- 2 The display shows all devices that have been paired before. Press **Up**  or **Down**  to choose the desired device, press  beneath **Select** to complete the connection.
- 3 When the connection is successful, **Connected to phone audio** appears below **G-700** on the Galaxy screen.

Note:

- If you switch off the Bluetooth function on the Galaxy then switch on, you must connect it again.

Disconnecting a Galaxy







- 1 Press  beneath **Menu** to display the main menu items.
- 2 Press  to choose  ^{Bluetooth}, then press  beneath **Select**.
- 3 Press **Down**  to choose **Device list**, press  beneath **Select**.
- 4 The display shows all devices that have been paired before. Press **Up**  or **Down**  to choose the desired device, press  beneath **Select**.
- 5 Press  beneath **Select** to choose **Disconnect**. Then a prompt tone occurs and **Paired** appears instead of **Connected to phone audio** below **G-700** on the Galaxy screen.

Notes:

- At step 3, if the list is empty, "**No record.**" appears.
- When "**Missed calls xx**" appears, you can press the **OK** key to access the Incoming Calls list.
- If the caller has specified that his name and number not be sent, "**Private**" appears on the screen and in the list.
- "**Out of area**" appears and is stored in the incoming call list when someone calls from an area where the telephone company does not offer identification services or name and number delivery to your region.

Answered and Missed Calls Options

You can save or delete a number in the missed calls list, as follows:

- 1 Find the desired number in the incoming calls list.
- 2 Press  beneath **Select** to display the call information.
- 3 Press  beneath **Select** to display the option menus.
- 4 Press **Up**  or **Down**  to choose the desired option:
 - **Add to contacts** - allows you to save the number in the contacts list. If the number is longer than 16 digits, you can store only first 16 digits of the number.
 - **Delete** - deletes the selected number.
 - **Delete all** - allows you to delete the whole incoming calls list (a prompt confirms your intent). Press  beneath **Select** to confirm or  beneath **Cancel** to exit without deleting the entries.















Chapter 5: Call Logs

Answered or Missed Calls

When you receive a call and you subscribe to your network provider's caller ID service, if the caller's information is transmitted from the network on which the call was made (and the caller doesn't hide it), the caller's phone number is displayed. Additionally, you miss calls "Missed calls" followed by the number of missed calls (01, 02, etc.) and the icon  appears.













The last 30 received (or missed) calls are stored in the **Answered calls** list (or **Missed calls** list), and you can call back the numbers, delete them or store them in the contacts list. To view the numbers, you can access the **Answered calls** list (or **Missed calls** list).

Reviewing or Dialing a Number in the Incoming Calls List

- 1 Press  beneath **Menu** to display the main menu items.
- 2 Press  to choose  ^{Call logs}, then press  beneath **Select**.
- 3 Press  beneath **Select** to access **Missed calls** or press **Down**  to choose **Answered calls**. Press  beneath **Select** to confirm. The list of incoming calls appears. Numbers received via a landline appear with , and numbers received via cellphone line appear with .
- 4 Scroll through the relevant calls list using **Up**  or **Down**  until you find the desired number, and then press  beneath **Select**. The date/time that you received the call appears.
- 5 To dial a number through your landline, press  or dial it through your Galaxy using .

Removing a Paired Galaxy

If you already have the maximum of **seven** paired **Galaxies** in the Device list and you want to add another **Galaxy**, you must first delete a paired **Galaxy**.

- 1 Press  beneath **Menu** to display the main menu items.
- 2 Press  to choose  ^{Bluetooth}, then press  beneath **Select**.
- 3 Press **Down**  to choose **Device list**, and then press  beneath **Select**.
- 4 The display shows all devices that have been paired. Press **Up**  or **Down**  to choose the one you want to remove, and then press  beneath **Select**.
- 5 Press **Down**  to choose **Remove**, and then press  beneath **Select**. The display shows **Remove ? Galaxy S II**. Press  beneath **Select** to confirm. After successful operation, a confirm tone occurs.
- 6 On your Galaxy, press and hold **G-700**, then click **Unpair** or **Disconnect and unpair**.

Reminder

Some of Instant Messenger, such as Viber, Skype, Fring, Im+, Nettek..... may not well support Bluetooth protocol, please check with relevant providers and update the software to use G-700 properly.

Thanks!



Chapter 3: Basic Functions

Making a Call

When you dial, up to 25 digits appear on the screen. If the number is longer than 16 digits, the digits become smaller to accommodate the whole number.



You can place your calls in two ways:

Traditional Mode

- 1 Pick up the handset and press  to engage the line. You hear a dial tone, and  appears.
- 2 Dial a telephone number. The number appears on the screen. When you hear your called party, speak with a normal voice.
- 3 To end the call, press  or place the handset on the base.

High-featured Mode

This procedure is more convenient and reliable, because you can check the number as you enter it:











- 1 Enter a telephone number. Press and hold  to insert a pause if necessary. Check the number on the display.
- 2 If you make a mistake, correct it by using  beneath **Delete**.
- 3 When the number correctly appears, press  to dial it out through a landline.

Or press  to dial through your **Galaxy**.

Note: The DECT phone must first be connected to the **Galaxy** via Bluetooth. For more details please refer to **Bluetooth** section.

Charging Tone

Every time you place the handset on the base, a tone occurs. This tone confirms that the handset is charging. You can switch the tone **ON** or **OFF**.











- 1 Press  beneath **Menu** to display the main menu items.
- 2 Press  to choose  **Sound**, then press  beneath **Select**.
- 3 Press **Up**  or **Down**  to choose **Charging tone**, then press  beneath **Select**.
- 4 Press **Up**  or **Down**  to choose "ON" to activate this feature or choose "OFF" to deactivate it, and then press  beneath **Select**.

Note:

- For normal use, we recommend that you leave the charging tone enabled. This makes the phone easier to use and avoids the risk improper placement in the charging cradle. In this case, the handset would not charge and it might go unnoticed.

Key Tone

Every time that you press a key, your handset acknowledges it with a key tone. You can disable the key tones.











- 1 Press  beneath **Menu** to display the main menu items.
- 2 Press  to choose  , then press  beneath **Select**.
- 3 Press **Up**  or **Down**  to choose **Key tone**, then press  beneath **Select**.
- 4 Press **Up**  or **Down**  to choose "ON" to activate this feature or choose "OFF" to deactivate it, press  beneath **Select**.

Note:

- For normal use, we recommend that you leave the key tones enabled. This makes the phone easier to use.



Power Off Tone

When you turn off the handset, it generates a tone. You can disable the tone.

- 1 Press  beneath **Menu** to display the main menu items.
- 2 Press the navigation keys  to choose  , then press  beneath **Select**.
- 3 Press **Up**  or **Down**  to choose **Power off tone**, then press  beneath **Select**.
- 4 Press **Up**  or **Down**  to choose "ON" to activate this feature or choose "OFF" to deactivate it, and then press  beneath **Select**.

Call Switching between the DECT Phone and a Galaxy

During a call, you can switch between your DECT phone and your **Galaxy**.

- 1 During a cell line call using the DECT phone, click  (the bar below **Bluetooth** is green) on the display of the Galaxy. The call switches to the Galaxy.
- 2 To switch back, click  (the bar below **Bluetooth** is gray) on the Galaxy. The call switches back to the DECT phone.



Note:



- To use this feature, the DECT phone must be paired and connected to the Galaxy beforehand. For more details, please refer to **Bluetooth** section.

Options during a call

During a call, you can press  beneath **Option**, and then select **Hold** to put the call on hold, or select **Contacts** to enter the Contacts list.

Receiving a Call

When a call is received, the phone rings and "Incoming Call" appears on the screen.  indicates a landline call or  indicates a cellphone line call. If the incoming call can be identified (i.e. The caller's information is transmitted) you also see the caller's number.

Press  to answer a landline call or press  to answer a cell line call when your Galaxy is charging. Or if the handset is on the base and you have activated the "Auto Answer" function (See page 51 for details), simply pick it up to answer the call. During conversation, the screen shows the elapsed time.



















To end the call, press  or replace the handset on the base.

Note:

- The caller is identified only if your telephone network and the caller's network supports the service. However, a caller can still hide his/her number.

Ring Setting









You can select unique cell, landline and internal call ring tones and volumes. There are 15 ringtones, and four volume levels. You can also turn off the ringer.

- 1 Press  beneath **Menu** to display the main menu items.
- 2 Press  to choose , then press  beneath **Select**.
- 3 Press  beneath **Select** to choose **Cell ringtone**, or press **Up**  or **Down**  to choose **PSTN ringtone** or **INT ringtone**, then press  beneath **Select**.
- 4 Press **Left**  or **Right**  to select the ring tone that you like. Each time you press **Left**  or **Right** , the handset sounds with the selected ring.
- 5 Press  beneath **Select** to save the ring tone setting and enter the ring volume setting.
- 6 Press **Left**  or **Right**  to choose the volume level that you want. Each time you press **Left**  or **Right** , the handset sounds with the selected volume.
- 7 Press  beneath **Select** to save the settings and return to the previous menu.













Notes:

- If you turn off the ringer, when a call comes in, only the incoming call message appears on the display.
- You can also turn the PSTN ring off/on by long pressing  when the line is not engaged.

Background Color



- 1 Press  beneath **Menu** to display the main menu items.
- 2 Press  to choose , then press  beneath **Select**.
- 3 Press **Up**  or **Down**  to choose **Background**, then press  beneath **Select**. The current setting appears on the screen.
- 4 Press  to choose among 9 pre-defined colors, then press  beneath **Select**.



Handset Name

- 1 Press  beneath **Menu** to display the main menu items.
- 2 Press  to choose , then press  beneath **Select**.
- 3 Press **Up**  or **Down**  to choose **Handset name**, then press  beneath **Select**.
- 4 Press **Up**  or **Down**  to choose "ON", press  beneath **Select**.
- 5 Enter the name, up to 15 characters long that you want to assign to the handset, and then press  beneath **Save**.
- 6 Press . The handset name appears.
- 7 To deactivate this feature, access the **Handset name** menu and choose "OFF", press  beneath **Select**.

Using the Speakerphone

During a call, you can turn on the speakerphone that is built into the handset. You can simply put your handset on a surface (e.g. a desk) and enjoy the comfort of a handsfree conversation.

To turn on the speakerphone, press  during a call.  appears.

To turn off the speakerphone, press .  disappears.

Adjusting the Volume

During a conversation, press the **Up** or **Down** key to adjust the earpiece volume (or the handsfree speakerphone volume). There are five levels, which are shown by the bars of .

When the last bar is red, the volume is at its maximum level.

Muting a Call

During a conversation, you can temporarily mute the microphone so that the party on the other end of the line cannot hear you. You can still hear the other party. This enables you to converse privately with someone near you.

To mute your microphone, press the **Right**  during the conversation:  appears.



To unmute the microphone, press the **Right** :  disappears.

Last Number Redial

Your phone allows you to quickly redial the last dialed number.

Pick up the handset and press  to engage the line. Then press  beneath **Redial** to dial the last-dialed number.



Flash Signal

If your phone service includes call waiting or conference call services, you can use  to initiate these functions. For further details please contact your telephone company. Additionally, if you are connected to an extension line (PABX), you can use  to transfer a call to another extension.

To initiate any of these functions, press  while the line is engaged.

Using a Pause







A pause is useful when you access an interactive voice response system, such as an automated banking system. A pause provides a delay of 3 seconds.

After you dial a number and press , if you need to insert a 3-second pause, press  beneath **Pause**.









Chapter 4: Display and Sound

Display Contrast

This adjustment enables you to optimize the visibility of the display by changing its contrast according to environmental conditions.

- 1 Press  beneath **Menu** to display the main menu items.
- 2 Press  to choose , then press  beneath **Select**.
- 3 Press  beneath **Select** again to choose **Contrast**. The current setting appears.
- 4 Press  repeatedly to choose among the 11 available contrast levels, then press  beneath **Select**.

Wallpaper



- 1 Press  beneath **Menu** to display the main menu items.
- 2 Press  to choose , then press  beneath **Select**.
Press **Up**  or **Down**  to choose **Wallpaper**, then press  beneath **Select**. The current setting appears on the display.
- 4 Press  to choose among 12 pre-defined wall paper images, then press the Left .

Three-way Conference Calling



When you have an external call and an intercom call in progress, you can set up a three-way conference call, like this:



Press  beneath **Confer** to set up a three-way conference call.



Out of Range Indicator



The bars to the right of  show the signal strength received from the base. If you are too far from the base, the radio signal might become too weak for the phone to access the telephone line. In these conditions you can't make or receive phone calls, and  turns red and "**Searching...**" appears.

Locking the Keypad

This function is useful to avoid accidentally pressing keys when you are carrying your handset. If you activate keylock, all keys are inhibited except  and .

In this condition, when a call comes in, you can answer the call by pressing  or . When the call ends, the keys are locked again.

To lock the keys, press and hold  until  appears.

To unlock the keys, press and hold  until  disappears from the display.

Paging

You can page the handset from the base by making the handset ring with a special ring. It's useful to locate a lost handset or call the user who currently has the handset.

To send the paging signal, briefly press  , located on the base. All handsets registered with the base ring for 15 seconds.



To stop the paging signal before 15 seconds have passed, press  or any keys on the handset.

Note:

- If a call comes in while the handset is being paged, the handset stops the paging operation and starts ringing normally.



Temporary Tone-Dial Switchover

If you are using pulse dialing because your telephone line doesn't support tone dialing, you might not be able to access certain external services (e.g. automatic call centers, voice mailboxes, interactive telephone systems etc.), because they need tone dialing. You can avoid this limitation and access them anyway by doing this:

- 1 Pick up the handset and press  to engage the line.
- 2 Press and hold  until "-" is displayed: your DECT phone is temporarily in the tone dial mode.
- 3 Enter the number of the service that you need to access.
- 4 When you hang up, the phone automatically returns to the pulse mode.



Intercom

If you connected more than one handset to a base (you can connect up to 5 handsets to the same base), you can have a conversation between two people using two different handsets.

- 1 Pick up the handset and press **Left**  . The screen display shows "INT x ->" (x is your handset number).
- 2 Press the number of the handset that you want to contact (from 1 to 5). The called handset starts to ring.
- 3 If the called party can answer your call, he/she can press  and start talking. You can see the handset number of the called party on your screen.
- 4 At the end of the conversation, press .

Transferring Calls between Handsets

If you have more than one handset registered to the same base, you can transfer an outside call between the handsets.

- 1 When you are connected to an external call, press **Left**  and the number of the handset that you want to contact (from 1 to 5).
- 2 If the called party can answer your call, he/she can press  and start talking.
- 3 If you want to cancel the transfer before the called party answers, press **Left**  . The call transfer is cancelled.